

WORK, DRIVING, AND WARNING LIGHT PRODUCT CATALOG

1ST EDITION

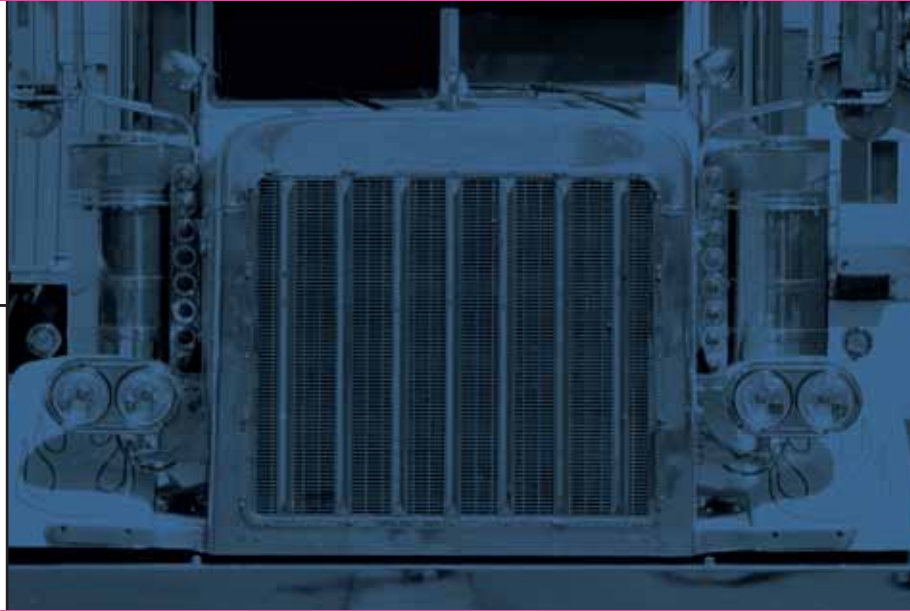

Quality.

Innovation.

Design.

MISSION STATEMENT

Here at United Pacific, we are dedicated to providing today's drivers with innovative and exciting products that deliver exceptional performance and value. Because United Pacific's continuing success depends on our customer's satisfaction, we constantly push our designers and engineers to upgrade our facilities and processes in order to bring products of superior quality and reliability to the market. We at United Pacific promise to continue our passionate pursuit to be the first in

QUALITY, INNOVATION AND DESIGN.

QUALITY

With over 30 years of experience in the heavy duty trucking industry, United Pacific Industries understand the rigors and stresses that our products are subjected to on the road. It is our mission to provide our customers with products of superior quality and reliability. In achieving this goal, United Pacific only partners with manufacturing facilities that conforms to our quality control requirements and standards. Our manufacturing partners meet or exceed ISO-9001 requirements. In addition, United Pacific's manufacturing partners must be equipped on site to perform the following quality assurance tests:

- AGING TEST
- AIR TIGHT TEST
- DUST TEST
- FLUX TEST
- PHOTOMETRIC TEST
- PULL FORCE TEST
- RAIN TEST
- SALT SPRAY TEST
- SHOCK TEST
- TEMPERATURE TEST
- HUMIDITY TEST
- VIBRATION TEST

United Pacific's manufacturing partners must maintain a track record of consistent quality and low product failure rate. Furthermore, our internal quality control structure allows us to function as the final quality control station prior to shipping. With the assistance of 3D computer technology, United Pacific can adhere to strict quality control standards during prototype creation and the production process. Our engineers and technicians perform a battery of tests to ensure that our products meet the demands of today's drivers and our goal to be first in quality.

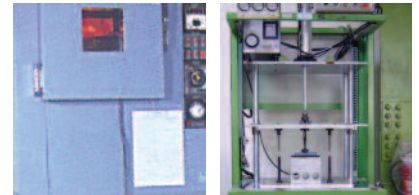



HOW TO ORDER

To order from United Pacific Industries, you must be an authorized dealer, distributor or OEM.

If you are not authorized to stock and sell United Pacific products, you must order through an authorized dealer. Please call 1 (800) 790-6988 for more information.

CONTACT US

United Pacific customer service representatives are available from:

8 am - 4:30 pm PST

Toll Free: 1 (800) 790-6988

Fax: 1 (888) 986-5988

Email: sales@uapac.com

Website: www.uapac.com

INNOVATION

Known as the leader in innovation, United Pacific is dedicated to be the first to bring new and exciting products to the market. United Pacific's global expertise allows us to search the globe for new ideas and concepts. Not only do we search the globe for new products, United Pacific invest a significant amount of resources into our own research and development efforts.



With the assistance of advance 3D scanning technology, our engineers and designers can acquire accurate and precise data in seconds. The 3D data allows United Pacific to verify designs, perform quality assurance tests, and reverse engineer with unprecedented speed and accuracy. Digital inspection contributes to the early detection of shape problems, provides rapid feedback on design, and eliminates unnecessary work in downstream processes. Our rapid prototyping facility permits us to have a concept-to-shelf time of less than 5 months.



In addition, United Pacific's 3D printing capabilities permit our designers to have physical models of their design concepts in hours. The physical models allow our designers and marketing staff to evaluate and test the viability of different design ideas. Our rapid prototyping facility allow United Pacific to compress design cycles, improve manufacturing planning, shorten concept-to-shelf time, most importantly, generate new and innovative products.

DESIGN

Located near some of the nation's most progressive automotive design centers, United Pacific established the UP Design Studio in 2002 to consolidate our position as the design leader in the heavy duty trucking industry. UP Design Studio utilizes the latest generation of computer aided design (CAD) and studio/graphic software. The design studio is equipped with the newest computers and rapid prototyping systems. In addition, UP Design Studio is staffed by graduates from the nation's most prestigious design colleges.



Unlike our competitors, United Pacific's design and manufacturing capabilities mean that we carry more new and original items than our competitors. The establishment of the design studio will enable us to generate even more new products with significant shorter concept-to-shelf time. The reduction in development cost mean that we can develop products utilizing design based development processes. Design based product development allows United Pacific to create new product concepts based on designs incorporating driver demands and needs instead of economic considerations. United Pacific's emphasis on design distinguishes and positions us ahead of our competitors.



Light Emitting Diodes (LED)

Low Voltage Operation

A low voltage device, LEDs draw minuscule amount of current from a vehicle's electrical system compared to incandescent devices. Low voltage draw protects and prolongs a vehicle's electrical system.

Instant On

LEDs light up in microseconds. Research conducted by the University of Michigan Transportation Research Institute indicates that motorist respond quicker to LEDs than incandescent lights.

Rugged & Durable

Being a solid-state device, LEDs contain no moving parts and filaments to break. Produced with similar technologies as the latest microprocessor, LEDs provide unparalleled reliability and dependability.

Cold Start Capacity

Unlike many light sources in use today, LEDs do not require any special drivers or equipment to operate in extreme cold temperature. Solid State technology allows LEDs to function in inhospitable environments, down to -40°.

WARRANTY

With LED (Light Emitting Diodes) rated at 100,000 hours of operation and solid-state construction, United Pacific's LED lights are extremely reliable and durable. Purchase with confidence, United Pacific offers a complete line of LED lighting products with extended warranties. Please see the warranty policy page for more details.



INVENTORY & SHIPPING

United Pacific carries over 20,000 items in our California distribution center. No other company in the heavy duty trucking industry can match United Pacific in the variety and range of in-stock inventories. With an order fill rate of over 98.5%, United Pacific is the largest and most reliable supplier in the industry. Our shipping department ships 96.8% of all orders within 24 hours and 98.9% within 48 hours. United Pacific's vast inventory and prompt shipping has made United Pacific the only source for our customer's chrome and lighting needs.



ASSEMBLED IN U.S.A

United Pacific strives to provide today's drivers with innovative and exciting products that deliver exceptional performance and value. With our international background and expertise, we search the globe for the best and most reliable products. However, as an American company, we believe and support the American way of life. Look for the "Assembled in the USA" label on many of our products. Although the components are manufactured overseas, the products, bearing the "Assembled in the USA" labels, are hand assembled with pride in the United States.



WEBSITE

United Pacific strives constantly to improve our existing facilities and procedures. As a part of our continuous improvement process, United Pacific will soon be updating our website. The new website will be even more comprehensive and in-depth. In addition, we will incorporate an online ordering system that will enable our customers to order and receive shipping updates online. The online ordering system will only be available to authorized retailers. The new website is just another example of United Pacific's ceaseless pursuit to be our customer's only source for their chrome and lighting needs.



Hard at work for our customers

UNITED PACIFIC SHANGHAI

In 2005, United Pacific opened United Pacific Shanghai. Staffed with 3 quality assessment engineers and 2 logistic support personnel, United Pacific Shanghai serves as United Pacific's quality control and logistics office in China. Located in the commercial center of China, the Shanghai office provides United Pacific with unparalleled access to local markets and suppliers. The open access translates into faster product development and more rigorous quality control standards. The opening of the Shanghai office means that there will be a United Pacific employee hard at work for our customers 24 hours a day in different parts of the world.

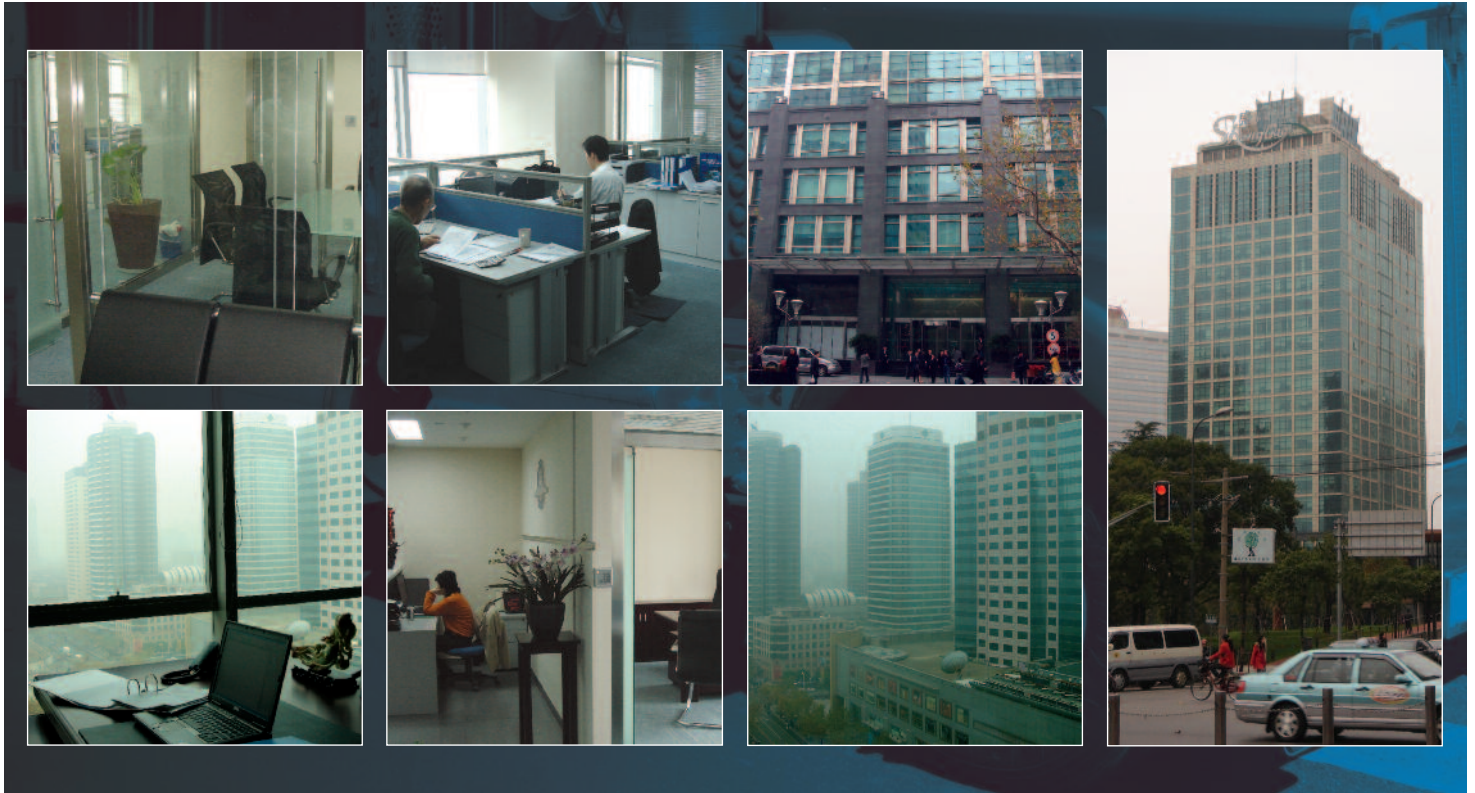

UNITED PACIFIC CHROME PLATING

United Pacific's commitment to quality led United Pacific to invest in its own chrome plating facility. With one chrome plating line fully operational and another in construction, the chrome plating plant will ensure that United Pacific products meet our strict quality control standards. Better products mean better sales for United Pacific customers.

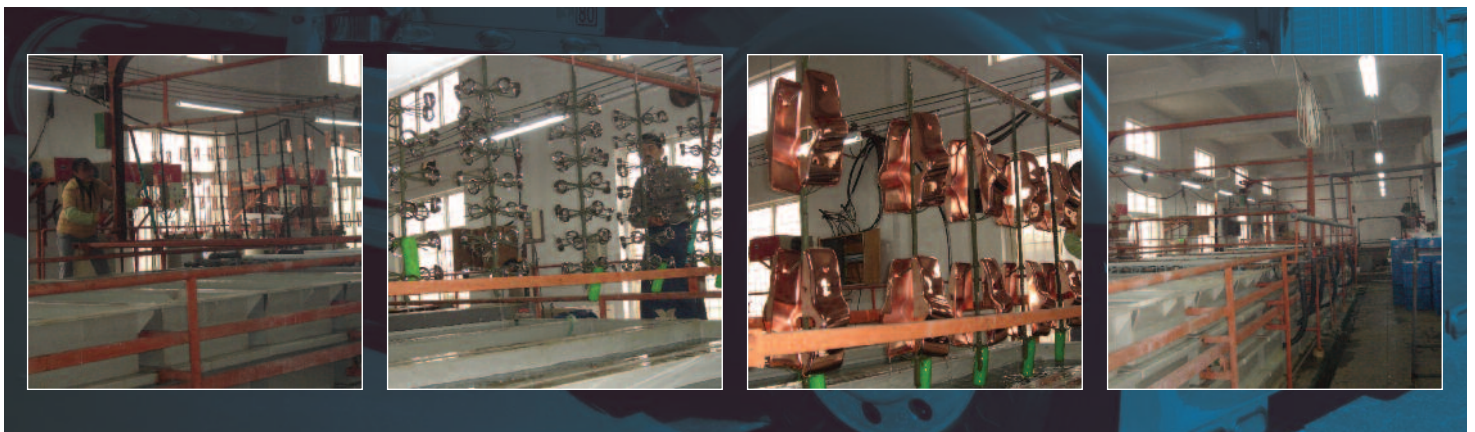

Hard at work for our customers

UNITED PACIFIC JOINT VENTURE

Here at United Pacific, collaboration is at the heart of our business. We partner with manufacturers that are as passionate about well-made and well-designed products as we are. In 2006, United Pacific entered into the ultimate collaboration. United Pacific formed a joint venture with China's largest manufacturer of heavy duty trucking products. The joint venture currently supplies all major American and Canadian aftermarket distributors (including United Pacific competitors) with stainless steel, chrome, and exhaust products. Because of our collaborative approach to product development and manufacturing, we're able to eliminate undue inefficiencies and cost. As a result, United Pacific customers benefit from unique products that are offered at the best possible price and the highest possible quality.

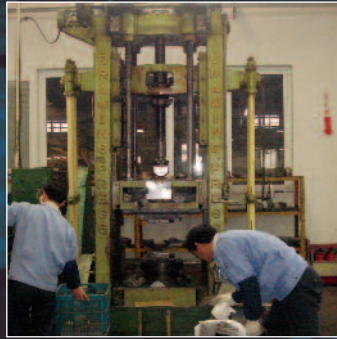
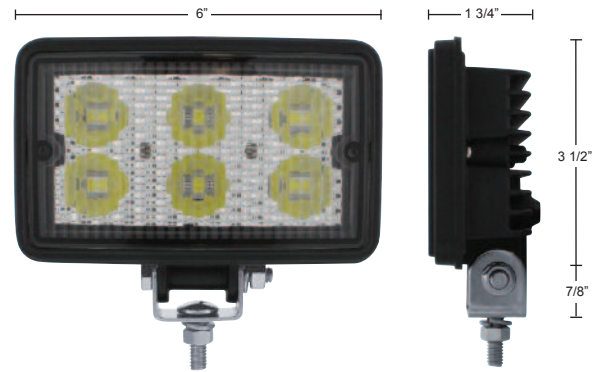

TABLE OF CONTENTS

LED WORK LIGHT		PAGE
Rectangular LED Work Light		
6 High Power LED Rectangular Work Light		2
5 High Power LED Rectangular Work Light		3
Square LED Work Light		
9 High Power LED Square Work Light		3
6 High Power SMD LED Square Work Light		4
9 High Power SMD LED Square Work Light		4
3 High Power LED Square Compact Work Light		5
1 High Power LED Square Mini Work Light		5
Round LED Work Light		
6 High Power LED Round Work Light		6
6 High Power LED Round Rubber Work Light		7
6 High Power LED Chrome Work Light		7
6 High Power LED Teardrop Work Light		7
6 High Power LED Par 36 Light		8
LED DRIVING LIGHT		PAGE
LED Driving Light		
7 High Power LED 5" Round Driving Light		8
10 High Power LED 7" Round Driving Light		8
WARNING LIGHT		PAGE
LED Warning Lighthouse		
4 High Power LED Warning Lighthouse		9
3 High Power LED Warning Lighthouse		9
3 High Power LED Warning Lighthouse with Chrome Bezel		9
3 High Power LED Warning Lighthouse with Black Bezel		10
3 High Power LED Mini Warning Lighthouse		10
4 High Power LED Square Warning Lighthouse		10
6 High Power LED Rectangular Warning Lighthouse		11
4 High Power LED Dash Warning Lighthouse		11
LED Warning Light Bar		
30 High Power LED Micro Warning Light Bar		12
18 High Power LED Mini Warning Light Bar		12
14 LED 12" Warning Light Bar		12
LED Beacon Light		
12 High Power LED Beacon Light		13
6 High Power LED Beacon Light		13
3 High Power LED Mini Beacon Light		13
1" Warning LED Light		
6 LED Mini Warning Light		14
REFERENCE		PAGE
Product Index		15
Warranty and Terms		16



6 High Power 5 Watt LED Rectangular Work Light - 1700 Lumens

Description

- 6 High Power, Extra Bright 5 Watt LED Rectangular Work Light
- 12V - 24V Application, 1700 Lumens, **3 Year Warranty**

HIGH POWER	LIGHT	MULTIPLE
5 WATT X 6	1700	12V - 24V
LED	LUMENS	VOLTAGE

Item Number	LEDs	Lumens	Function	Voltage	IP Rating	Pack
37563	5 Watt x 6	1700	Flood	12V - 24V	IP67	1 Pc./Card

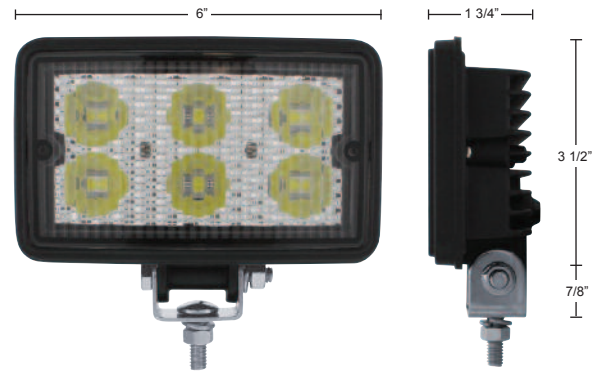

6 High Power 1 Watt LED Rectangular Work Light - 500 Lumens

Description

- 6 High Power, Extra Bright 1 Watt LED Rectangular Work Light
- 12V - 24V Application, 500 Lumens, **3 Year Warranty**

HIGH POWER	LIGHT	MULTIPLE
1 WATT X 6	500	12V - 24V
LED	LUMENS	VOLTAGE

Item Number	LEDs	Lumens	Function	Voltage	IP Rating	Pack
39901	1 Watt x 6	500	Flood	12V - 24V	IP67	1 Pc./Card

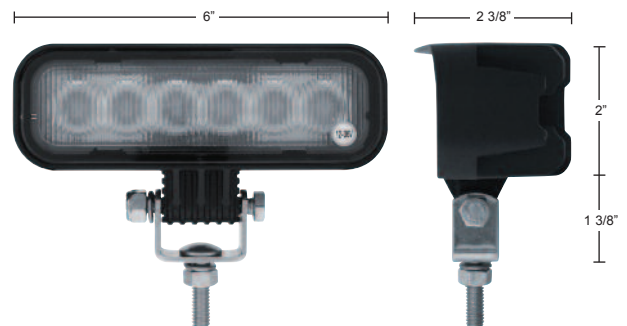

6 High Power 2.5 Watt SMD LED Rectangular Work Light - 1200 Lumens

Description

- 6 High Power 2.5 Watt SMD LED Rectangular Work Light
- 12V - 36V Application, 1200 Lumens, **3 Year Warranty**

HIGH POWER	LIGHT	MULTIPLE
2.5 WATT X 6	1200	12V - 36V
LED	LUMENS	VOLTAGE

Item Number	LEDs	Lumens	Function	Voltage	IP Rating	Pack
37123	2.5 Watt x 6	1200	Flood	12V - 36V	IP67	1 Pc./Card

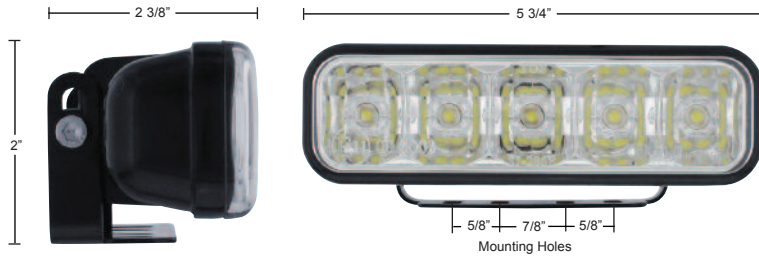

5 High Power 1 Watt LED Rectangular Work Light - 400 Lumens

Description

- 5 High Power, Extra Bright 1 Watt LED Rectangular Work Light
 - 12V - 24V Application, Hard Wire with 2 Wires, **3 Year Warranty**

Item Number	LEDs	Lumens	Function	Voltage	IP Rating	Pack
39993	1 Watt x 5	400	Utility	12V - 24V	Not Rated	1 Pc./Card

HIGH POWER 1 WATT X 5 LED	LIGHT 400 LUMENS	MULTIPLE 12V - 24V VOLTAGE
--	---	---



9 High Power 3 Watt LED Square Work Light - 1800 Lumens

Description

- 9 High Power 3 Watt LED Working Light, Available with Flood or Spot Light Function
 - 12V - 36V Application, 1800 Lumens, **3 Year Warranty**

Item Number	LEDs	Lumens	Function	Voltage	IP Rating	Pack
37174B	3 Watt x 9	1800	Flood	12V - 36V	IP67	Bulk = 1 Pc.
37175B	3 Watt x 9	1800	Spot	12V - 36V	IP67	Bulk = 1 Pc.

HIGH POWER 3 WATT X 9 LED	LIGHT 1800 LUMENS	MULTIPLE 12V - 36V VOLTAGE
--	--	---



9 High Power 3 Watt LED Square Work Light - 1580 Lumens

Description

- 9 High Power 3 Watt Square Work Light
 - 12V - 36V Application, 1580 Lumens, **3 Year Warranty**

Item Number	LEDs	Lumens	Function	Voltage	IP Rating	Pack
37597	3 Watt x 9	1580	Flood	12V - 36V	IP67	1 Pc./Card
37598	3 Watt x 9	1580	Spot	12V - 36V	IP67	1 Pc./Card

HIGH POWER 3 WATT X 9 LED	LIGHT 1580 LUMENS	MULTIPLE 12V - 36V VOLTAGE
--	--	---



6 High Power 3 Watt LED Square Work Light - 1200 Lumens

Description

- 6 High Power 3 Watt LED Square Work Light
 - 12V - 36V Application, 1200 Lumens, **3 Year Warranty**

HIGH POWER	LIGHT	MULTIPLE
3 WATT X 6	1200	12V - 36V
LED	LUMENS	VOLTAGE

Item Number	LEDs	Lumens	Function	Voltage	IP Rating	Pack
37622B	3 Watt x 6	1200	Flood	12V - 36V	IP67	Bulk = 1 Pc.



9 High Power 0.5 Watt LED Square Work Light - 500 Lumens

Description

- 9 High Power 0.5 Watt LED Square Work Light
 - 12V - 24V Application, 500 Lumens, Black Plastic Housing, **3 Year Warranty**

HIGH POWER	LIGHT	MULTIPLE
0.5 WATT X 9	500	12V - 24V
LED	LUMENS	VOLTAGE

Item Number	LEDs	Lumens	Function	Voltage	IP Rating	Pack
37552B	0.5 Watt x 9	500	Flood	12V - 24V	IP67	Bulk = 1 Pc.



9 High Power 0.5 Watt SMD LED Square Work Light - 500 Lumens

Description

- 9 High Power 0.5 Watt SMD LED Square Work Light
 - 12V - 24V Application, 500 Lumens, Black Plastic Housing, **3 Year Warranty**

HIGH POWER	LIGHT	MULTIPLE
0.5 WATT X 9	500	12V - 24V
LED	LUMENS	VOLTAGE

Item Number	LEDs	Lumens	Function	Voltage	IP Rating	Pack
37553	0.5 Watt x 9	500	Flood	12V - 24V	IP67	1 Pc./Card

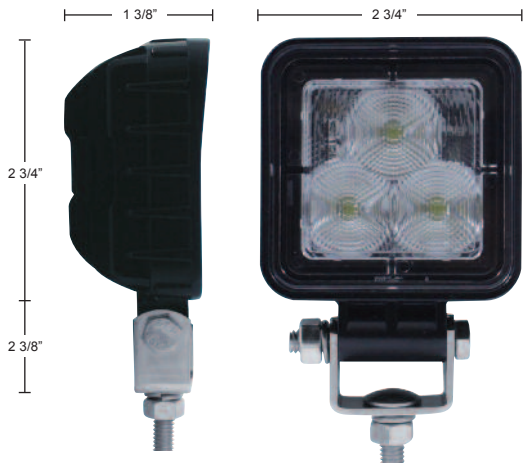

3 High Power 3 Watt LED Compact Work Light - 600 Lumens

Description

- 3 High Power 3 Watt LED Compact Work Light
 - 12V - 36V Application, 600 Lumens, **3 Year Warranty**

Item Number	LEDs	Lumens	Function	Voltage	IP Rating	Pack
37157	3 Watt x 3	600	Flood	12V - 36V	IP67	1 Pc./Card

HIGH POWER 3 WATT X 3 LED	LIGHT 600 LUMENS	MULTIPLE 12V - 36V VOLTAGE
--	---	---

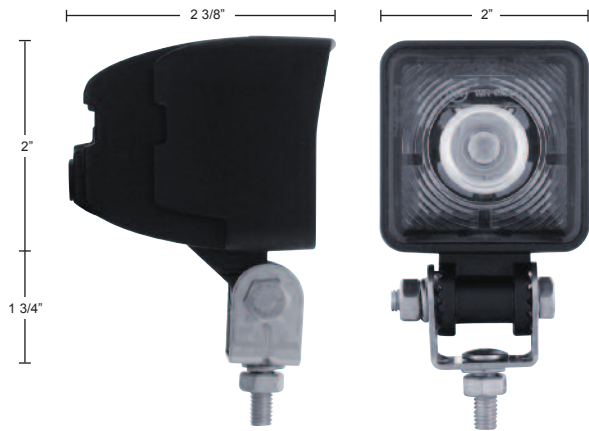

1 High Power 10 Watt LED Mini Work Light - 800 Lumens

Description

- 1 High Power 10 Watt LED Mini Work Light
 - 12V - 36V Application, 800 Lumens, **3 Year Warranty**

Item Number	LEDs	Lumens	Function	Voltage	IP Rating	Pack
37088	10 Watt x 1	800	Flood	12V - 36V	IP67	1 Pc./Card

HIGH POWER 10 WATT LED	LIGHT 800 LUMENS	MULTIPLE 12V - 36V VOLTAGE
---	---	---

Hot Items

11 High Power LED 7" Crystal Headlight

Item Number	Description	Package	Pack
31355	11 LED Headlight	Boxed	1 Pc./Box

Low Beam Application 12-24V DC Input 1.172 Amps @ 12.8V DC (24W) 0.55 Amps @ 28.0V DC (15.4W) FMVSS108	High Beam Application 12-24V DC Input 1.875 Amps @ 12.8V DC (24W) 0.87 Amps @ 28.0V DC (24.4W) FMVSS108
---	--



16 High Power LED 7" Crystal Headlight

Item Number	Description	Package	Pack
31354	16 LED Headlight	Boxed	1 Pc./Box

Low Beam Application 12-24V DC Input 1.80 Amps @ 12.8V DC (23.04W) 0.80 Amps @ 28.0V DC (22.40W) FMVSS108	High Beam Application 12-24V DC Input 1.85 Amps @ 12.8V DC (23.68W) 0.80 Amps @ 28.0V DC (22.40W) FMVSS108
--	---

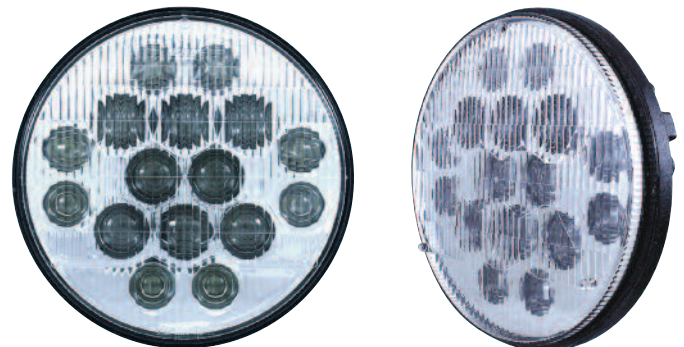



6 High Power 5 Watt LED Round Work Light - 1400 Lumens

Description

- 6 High Power, Extra Bright 5 Watt LED Round Work Light with Visor
- 12V - 24V Application, 1400 Lumens, [3 Year Warranty](#)

HIGH POWER	LIGHT	MULTIPLE
5 WATT X 6	1400	12V - 24V
LED	LUMENS	VOLTAGE

Item Number	LEDs	Lumens	Function	Voltage	IP Rating	Pack
37562	5 Watt x 6	1400	Flood	12V - 24V	IP67	1 Pc./Card



6 High Power 1 Watt LED Round Work Light - 500 Lumens

Description

- 6 High Power, Extra Bright 1 Watt LED Round Work Light with Visor
- 12V Application, 500 Lumens, [3 Year Warranty](#)

HIGH POWER	LIGHT	MULTIPLE
1 WATT X 6	500	12V - 24V
LED	LUMENS	VOLTAGE

Item Number	LEDs	Lumens	Function	Voltage	IP Rating	Pack
39688	1 Watt x 6	500	Flood	12V	IP67	1 Pc./Card

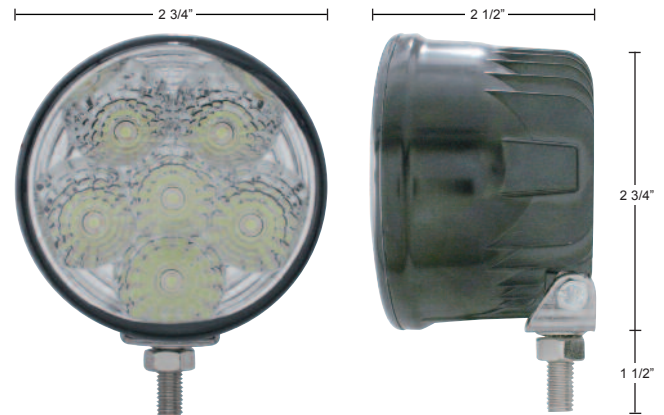

6 High Power 1 Watt LED Round Work Light - 480 Lumens

Description

- 6 High Power, Extra Bright 1 Watt LED Round Work Light
- 12V Application Only, 480 Lumens, [3 Year Warranty](#)

HIGH POWER	LIGHT	MULTIPLE
1 WATT X 6	480	12V
LED	LUMENS	VOLTAGE

Item Number	LEDs	Lumens	Function	Voltage	IP Rating	Pack
39979	1 Watt x 6	480	Spot	12V	IP65	1 Pc./Box



6 High Power 3 Watt LED Rubber Work Light - 750 Lumens

Description

- Rubber Work Light with 6 High Power 3 Watt LED Par 36 Light
- Universal Swivel Mounting Bracket, 750 Lumens, 12V - 24V Application, **3 Year Warranty**

Item Number	LEDs	Lumens	Function	Voltage	IP Rating	Pack
37556B	3 Watt x 6	750	Flood	12V - 24V	Not Rated	Bulk = 1 Pc.

HIGH POWER	LIGHT	MULTIPLE
3 WATT X 6	750	12V - 24V
LED	LUMENS	VOLTAGE



6 High Power 3 Watt LED Chrome Work Light - 750 Lumens

Description

- Chrome Work Light with 6 High Power 3 Watt LEDs
- Universal Swivel Mounting Bracket, 750 Lumens, 12V - 24V Application, **6 Month Warranty**

Item Number	LEDs	Lumens	Function	Voltage	IP Rating	Pack
30640	3 Watt x 6	750	Flood	12V - 24V	Not Rated	1 Pc./Box

HIGH POWER	LIGHT	MULTIPLE
3 WATT X 6	750	12V - 24V
LED	LUMENS	VOLTAGE

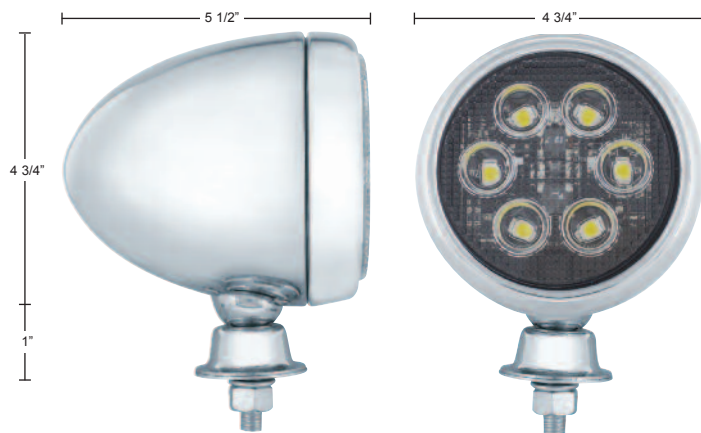

6 High Power 3 Watt LED Teardrop Work Light - 750 Lumens

Description

- 6 High Power 3 Watt LED Teardrop Work Light, Universal Swivel Mounting Bracket
- Available with Chrome or Stainless Housing, 750 Lumens, 12V - 24V Application, **6 Month Warranty**

Item Number	Housing	LEDs	Lumens	Function	Voltage	Pack
30659	Chrome	3 Watt x 6	750	Flood	12V - 24V	1 Pc./Box
30660	Stainless	3 Watt x 6	750	Flood	12V - 24V	1 Pc./Box

HIGH POWER	LIGHT	MULTIPLE
3 WATT X 6	750	12V - 24V
LED	LUMENS	VOLTAGE

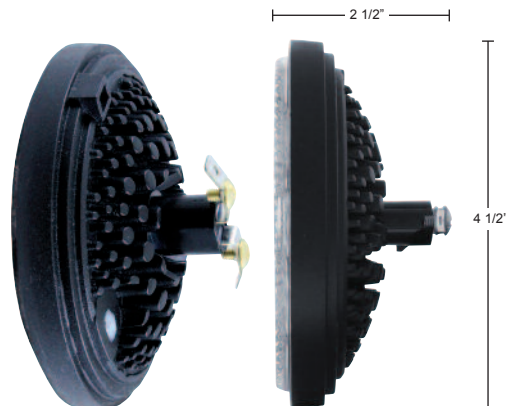

6 High Power 3 Watt LED Par 36 Light - 750 Lumens

Description

- 6 High Power 3 Watt LED Par 36 Light
- 750 Lumens, 12V - 24V Application, **3 Year Warranty**

HIGH POWER	LIGHT	MULTIPLE
3 WATT X 6	750	12V - 24V
LED	LUMENS	VOLTAGE

Item Number	LEDs	Lumens	Function	Voltage	IP Rating	Pack
37561B	3 Watt x 6	750	Flood	12V - 24V	Not Rated	Bulk = 1 Pc.



7 High Power 3 Watt LED 5" Driving Light - 950 Lumens

Description

- 7 High Power 3 Watt LED 5" Driving Light
- 950 Lumens, 12V - 24V Application, **3 Year Warranty**

HIGH POWER	LIGHT	MULTIPLE
3 WATT X 7	950	12V - 24V
LED	LUMENS	VOLTAGE

Item Number	LEDs	Lumens	Function	Voltage	IP Rating	Pack
38801	3 Watt x 7	950	Driving	12V - 24V	Not Rated	Bulk = 1 Pc.



10 High Power 3 Watt LED 7" Driving Light - 1300 Lumens

Description

- 10 High Power 3 Watt LED 7" Driving Light
- 1300 Lumens, 12V - 24V Application, **3 Year Warranty**

HIGH POWER	LIGHT	MULTIPLE
3 WATT X 10	1300	12V - 24V
LED	LUMENS	VOLTAGE

Item Number	LEDs	Lumens	Function	Voltage	IP Rating	Pack
38802	3 Watt x 10	1300	Driving	12V - 24V	Not Rated	Bulk = 1 Pc.

4 High Power LED Warning Lighthead

Description

- 4 High Power LED Warning Lighthead with Deluxe Chrome Bezel
- 12V - 24V Application, Surface Mount, 12 Flash Pattern, Multiple Light Synchronization, Mounting Holes are 5 3/16" Apart
- Approximate Size: 5 3/4" L x 1 3/4" W x 7/8" H, **3 Year Warranty**

Item Number	LEDs	Application	Flash Pattern	Pack
37233	4 Amber	12V - 24V	12	1 Pc./Box
37234	4 Blue	12V - 24V	12	1 Pc./Box
37235	4 Red	12V - 24V	12	1 Pc./Box
37236	4 White	12V - 24V	12	1 Pc./Box
37237	2 Amber / 2 White	12V - 24V	12	1 Pc./Box
37238	2 Blue / 2 Red	12V - 24V	12	1 Pc./Box

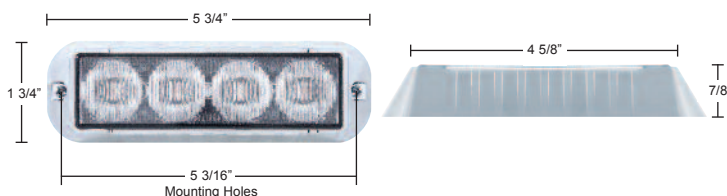

3 High Power LED Warning Lighthead

Description

- 3 High Power LED Warning Lighthead with Deluxe Chrome Bezel
- 12V - 24V Application, Surface Mount, 12 Flash Pattern, Multiple Light Synchronization, Mounting Holes are 4 1/8" Apart
- Approximate Size: 4 3/4" L x 1 3/4" W x 7/8" H, **3 Year Warranty**

Item Number	LEDs	Application	Flash Pattern	Pack
37627B	3 Amber	12V - 24V	12	Bulk = 1 Pc.
37628B	3 Blue	12V - 24V	12	Bulk = 1 Pc.
37629B	3 Red	12V - 24V	12	Bulk = 1 Pc.
37582B	3 White	12V - 24V	12	Bulk = 1 Pc.

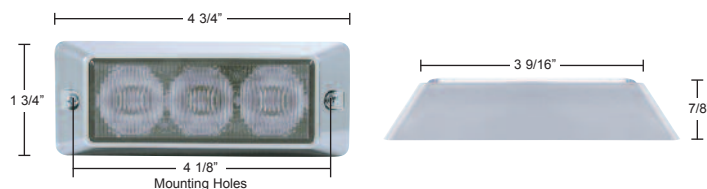

3 High Power LED Warning Lighthead

Description

- 3 High Power LED Warning Lighthead with Chrome Bezel
- 12V - 24V Application, Surface Mount, 12 Flash Pattern, Multiple Light Synchronization, Mounting Holes are 3 1/4" Apart
- Approximate Size: 3 7/8" L x 1 5/8" W x 1 1/2" H, **3 Year Warranty**

Item Number	LEDs	Application	Flash Pattern	Pack
37538B	3 Amber	12V - 24V	12	Bulk = 1 Pc.
37540B	3 Red	12V - 24V	12	Bulk = 1 Pc.
37541B	3 White	12V - 24V	12	Bulk = 1 Pc.

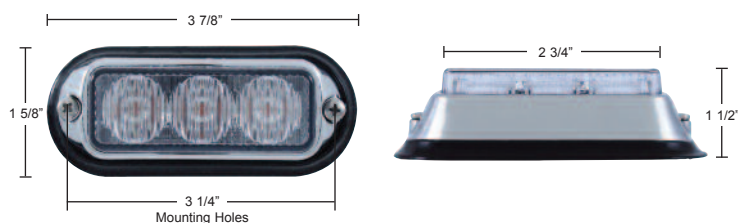

3 High Power LED Warning Lighthead

Description

- 3 High Power LED Warning Lighthead with Black Bezel
- 12V - 24V Application, Surface Mount, 12 Flash Pattern, Multiple Light Synchronization, Mounting Holes are 3 1/4" Apart
- Approximate Size: 3 7/8" L x 1 5/8" W x 1 1/2" H, **3 Year Warranty**

Item Number	LEDs	Application	Flash Pattern	Bezel
37534B	3 Amber	12V - 24V	12	Black
37536B	3 Red	12V - 24V	12	Black
37537B	3 White	12V - 24V	12	Black



Mini 3 High Power LED Warning Lighthead

Description

- Mini 3 High Power LED Warning Lighthead, Low Profile
- 12V - 24V Application, Surface Mount, 12 Flash Pattern, Multiple Light Synchronization, Mounting Holes are 3 1/16" Apart
- Approximate Size: 3 3/8" L x 1 1/16" W x 9/16" H, **3 Year Warranty**

Item Number	LEDs	Application	Flash Pattern	Pack
37542B	3 Amber	12V - 24V	12	Bulk = 1 Pc.
37544B	3 Red	12V - 24V	12	Bulk = 1 Pc.
37545B	3 White	12V - 24V	12	Bulk = 1 Pc.

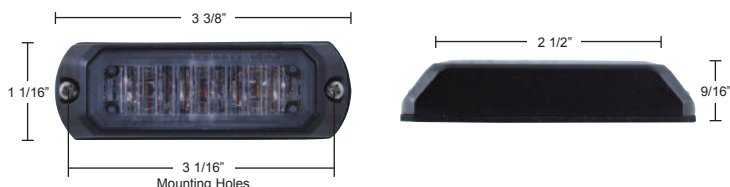

4 High Power LED Square Warning Lighthead

Description

- 4 High Power LED Square Warning Lighthead
- 12V - 24V Application, Stud Mount, 19 Flash Pattern, **3 Year Warranty**

Item Number	LEDs	Application	Flash Pattern	Pack
37186B	4 Amber	12V - 24V	19	1 Pc.
37187B	4 Blue	12V - 24V	19	1 Pc.
37188B	4 Red	12V - 24V	19	1 Pc.
37189B	4 White	12V - 24V	19	1 Pc.

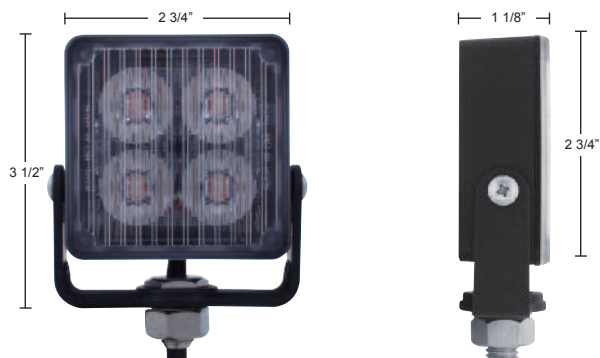

6 High Power LED Rectangular Warning LightheadDescription

- 6 High Power LED Rectangular Warning Lighthead
- 12V - 24V Application, Surface Mount, Single Flash Pattern
- Approximate Size: 5 1/2" L x 3 5/8" W x 1 5/8" H, **3 Year Warranty**

Item Number	LEDs	Application	Flash Pattern	Pack
37162B	6 Amber	12V - 24V	1	1 Pc.
37163B	6 Blue	12V - 24V	1	1 Pc.
37164B	6 Red	12V - 24V	1	1 Pc.

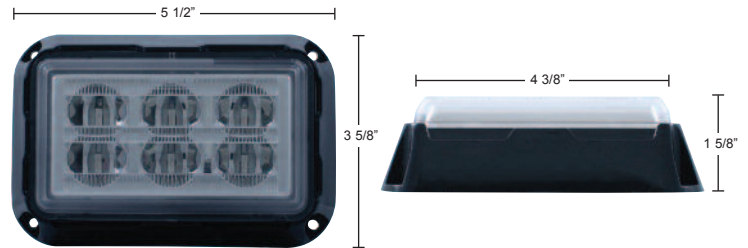
**6 High Power LED Rectangular Warning Lighthead**Description

- 6 High Power LED Warning Lighthead with Bracket
- 12V - 24V Application, Bracket Mount, Single Flash Pattern
- Approximate Size: 5" L x 3" W x 1 3/8" H, **3 Year Warranty**

Item Number	LEDs	Application	Flash Pattern	Pack
37158B	6 Amber	12V - 24V	1	1 Pc.
37159B	6 Blue	12V - 24V	1	1 Pc.
37160B	6 Red	12V - 24V	1	1 Pc.

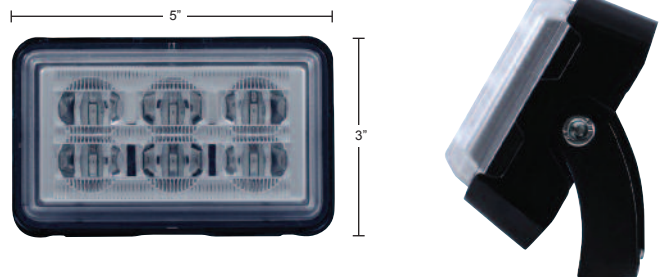
**4 High Power LED Dash Warning Light**Description

- 4 High Power LED Dash Warning Light with Cigarette Adaptor
- 11V - 30V Application, 19 Flash Pattern, Windshield Mount, **3 Year Warranty**

Item Number	LEDs	Application	Flash Pattern	Pack
37182B	4 Amber	11V - 30V	19	1 Pc.
37183B	4 Blue	11V - 30V	19	1 Pc.
37184B	4 Red	11V - 30V	19	1 Pc.
37185B	4 White	11V - 30V	19	1 Pc.



30 High Power LED Micro Warning Light Bar

Description

- 30 High Power LED Micro Warning Light Bar
- Available in Magnet Mount or Permanent Mount, 12V - 24V Application
- SAE J845, Class 1, and Class 2 Rated, **3 Year Warranty**

Item Number	Mount	Application	Flash Pattern
37140	Magnet Mount	12V - 24V	23
37141	Permanent Mount	12V - 24V	23



**SAE J845
Class 1
Class 2**



18 High Power LED Mini Warning Light Bar

Description

- 18 High Power LED Mini Warning Light Bar
- Available in Magnet Mount or Permanent Mount, 12V - 24V Application
- SAE J845, Class 1, and Class 2 Rated, **3 Year Warranty**

Item Number	Mount	Application	Flash Pattern
37138	Magnet Mount	12V	19
37139	Permanent Mount	12V	19

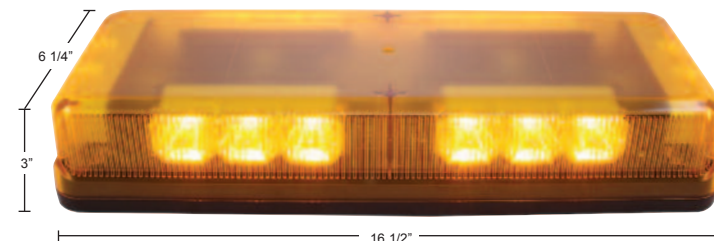

**SAE J845
Class 1
Class 2**



14 LED 12" Warning Light Bar with Chrome Bezel

Description

- 14 LED 12" Auxiliary Warning Light Bar with Chrome Plastic Bezel
- Available in Amber and Red LEDs with Clear Lens
- 6 Flash Pattern, Multiple Light Synchronization
- Mounting Screws Can Be Moved to Accommodate Mounting Distance from 4 1/2" - 7 3/8" Apart, Stainless Steel Mounting Hardware Included
- 12" Chrome Plastic Light Bar Bezel Available Separately: Item # 30933B

Item Number	LEDs	Lens	Flash Pattern	Pack
37190	14 Amber	Clear	6	1 Pc./Card
37191	14 Red	Clear	6	1 Pc./Card

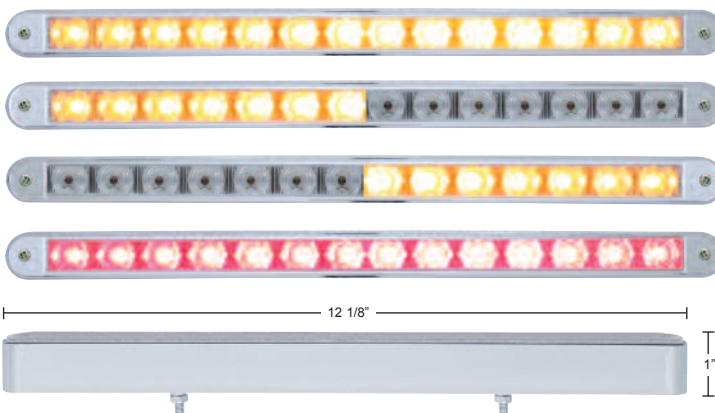

14 LED 12" Warning Light Bar

Description

- 14 LED 12" Auxiliary Warning Light Bar
- Available in Amber or Red LEDs with Clear Lens
- 6 Flash Pattern, Multiple Light Synchronization, **3 Year Warranty**

Item Number	LEDs	Lens	Flash Pattern	Pack
37192B	14 Amber	Clear	6	Bulk = 1 Pc.
37194B	14 Red	Clear	6	Bulk = 1 Pc.

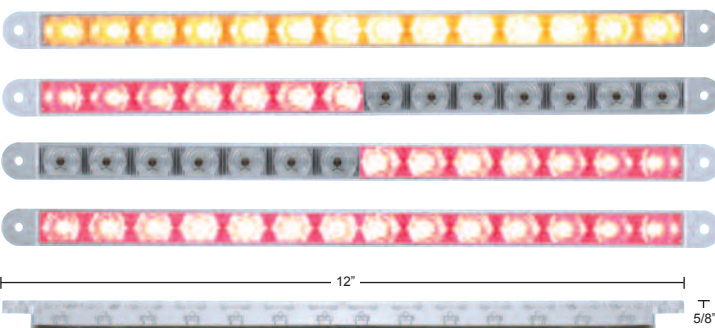

**SAE J845
Class 1
IP67**



12 High Power LED Beacon Light

Description

- 12 High Power LED Beacon Light with 5 Built in Flash Patterns
- SAE J845 and Class 1, IP67 Rated
- Available in Clear Lens with 12 High Power Amber LEDs, **3 Year Warranty**

Item Number	Mount	Application	Pack
37156B	Permanent Mount	9V - 36V	1 Pc.



6 High Power LED Beacon Light

Description

- 6 High Power LED Beacon Light
- Available with 2 Different Mounting Styles
- Flash Rate: 8 Flashes (45 FPM), 11V - 110V, **3 Year Warranty**

Item Number	Mount	Application	Pack
37176B	Magnetic Mount	11V - 110V	1 Pc.
37177B	Permanent Mount	11V - 110V	1 Pc.



3 High Power LED Mini Beacon Light

Description

- 3 High Power LED Mini Beacon Light
- Available in Magnet Mount or Permanent Mount
- Flash Rate: 8 Flashes (45 FPM), 12V - 110V, **3 Year Warranty**

Item Number	Mount	Application	Pack
37136	Magnet Mount	12V - 110V	1 Pc.
37137	Permanent Mount	12V - 110V	1 Pc.



6 LED 1" Mini Warning Light

Description

- 6 LED 1" Mini Warning Light, Grommet Mount into any 1" Opening
- 12V Application, 19 Flash Pattern, Multiple Light Synchronization
- Each Box Contains 2 Sets of 1" LED Mini Warning Light, **6 Month Warranty**

Item Number	LEDs	Application	Flash Pattern	Pack
37178B	6 Amber	12V	19	2 Pcs./Box
37179B	6 Blue	12V	19	2 Pcs./Box
37180B	6 Red	12V	19	2 Pcs./Box
37181B	6 White	12V	19	2 Pcs./Box



6 LED 1" Mini Warning Light - Flush Mount

Description

- 6 LED 1" Mini Flush Mount Warning Light with Chrome Bezel
- 12V Application, 19 Flash Pattern, Multiple Light Synchronization
- Mounting Holes are 1 7/8" Apart, Flush Mount, Mount onto any Flat Surface
- Each Box Contains 2 Sets of 1" LED Mini Warning Light, **6 Month Warranty**

Item Number	LEDs	Application	Flash Pattern	Pack
37146	6 Amber	12V	19	2 Pcs./Box
37147	6 Blue	12V	19	2 Pcs./Box
37148	6 Red	12V	19	2 Pcs./Box
37149	6 White	12V	19	2 Pcs./Box



HOT ITEMS

Patent Pending

21 LED 4" S/T/T & P/T/C Light - Halo

Description

- 21 LED 4" Round S/T/T & P/T/C "Halo" Light
- Unique Patent Pending "Halo" Design, Halo Effect on Running, All LEDs Lit on Stop
- 3 Contact Female Terminal, Available in Color or Clear Lens
- Recommended Plug: Item # 34212/34216, **Lifetime Warranty**

Item Number	LEDs	Lens	Package	Pack
37132	21 Red	Red	Carded	1 Pc./Card
37133	21 Amber	Amber	Carded	1 Pc./Card
37134	21 Red	Clear	Carded	1 Pc./Card
37135	21 Amber	Clear	Carded	1 Pc./Card

Patent Pending

22 LED 6" Oval S/T/T & P/T/C Light - Halo

Description

- 22 LED 6" Oval S/T/T & P/T/C "Halo" Light
- Unique Patent Pending "Halo" Design, Halo Effect on Running, All LEDs Lit on Stop
- 3 Contact Female Terminal, Available in Color or Clear Lens
- Recommended Plug: Item # 34212/34216, **Lifetime Warranty**

Item Number	LEDs	Lens	Package	Pack
37128	22 Red	Red	Carded	1 Pc./Card
37129	22 Amber	Amber	Carded	1 Pc./Card
37130	22 Red	Clear	Carded	1 Pc./Card
37131	22 Amber	Clear	Carded	1 Pc./Card



PRODUCT INDEX

Item No.	Page No.	Item No.	Page No.	Item No.	Page No.	Item No.	Page No.	Item No.	Page No.	Item No.	Page No.
30640	7	37541B	9								
30659	7	37542B	10								
30660	7	37544B	10								
31354	5	37545B	10								
31355	5	37552B	4								
37088B	5	37553B	4								
37123B	2	37556B	7								
37136	13	37561B	8								
37137	13	37562	6								
37138	12	37563	2								
37139	12	37582B	9								
37140	12	37597	3								
37141	12	37598	3								
37146	14	37622B	4								
37147	14	37627B	9								
37148	14	37628B	9								
37149	14	37629B	9								
37156B	13	38801	8								
37157B	5	38802	8								
37158B	11	39688	6								
37159B	11	39901	2								
37160B	11	39979	6								
37162B	11	39993	3								
37163B	11										
37164B	11										
37174B	3										
37175B	3										
37176B	13										
37177B	13										
37178B	14										
37179B	14										
37180B	14										
37181B	14										
37182B	11										
37183B	11										
37184B	11										
37185B	11										
37186B	10										
37187B	10										
37188B	10										
37189B	10										
37190	12										
37191	12										
37192B	12										
37194B	12										
37233	9										
37234	9										
37235	9										
37236	9										
37237	9										
37238	9										
37534B	10										
37536B	10										
37537B	10										
37538B	9										
37540B	9										

TERMS & CONDITIONS / ORDERING GUIDELINES / FREIGHT

IMPORTANT: PLEASE REVIEW CAREFULLY

New Accounts

Initial minimum buy-in is \$2,000 (or to be determined by United Pacific Industries, UPI hereafter). All initial orders must be prepaid in advance by Cashier's Check or VISA/MC. All new/potential accounts must complete a UPI "New Customer Info/Credit Form" and follow the Dealer Qualification Instructions. Upon completion of the credit application, approved accounts will be assigned payment terms of NET 30 Days (from invoice date). Accounts denied a credit line will be required to prepay in advance by Cashier's Check or VISA/MC.

Payment Terms:

Term Accounts

Accounts with NET 30 Days terms are required to submit payment within the 30 days from the date of invoice. Acceptable forms of payment include checks, ACH (Automated Clearing House), or wire transfer.

A service charge of 1.5% per month will be imposed on invoices not paid within the 30 day term. Delinquent accounts will be required to pay Cash-In-Advance (CIA). Checks will be accepted but orders will not be released until the check is cleared by the bank. Past due invoices will delay current orders. Please check with UPI on your account status when placing an order.

Credit Cards

Accounts denied credit terms may pay by Visa or MasterCard. Credit card will be charged upon shipment. Credit card payments will not be accepted once an order has been shipped. UPI does not accept American Express or Discover card.

COD

A \$11.00 fee will be assessed per COD box for all FedEx/UPS COD shipments. Truck COD shipment fees are to be determined later by trucking company.

Returned Checks:

A \$30 NSF (Non Sufficient Fund) fee will be assessed on each incidence a check is returned to UPI.

ORDERING GUIDELINES

Placing Orders: New orders may be placed by any of the following methods

1. Fax: **(888) 986-5988**
2. E-mail: **sales@uapac.com**
3. Telephone: In order to minimize errors, customers are encouraged to submit their orders by fax or email. Telephone orders should be limited to smaller orders such as add-ons to orders already submitted and/or fill-ins occurring between larger restocking orders.

Changes to Orders:

Whenever possible, revisions to orders - additions or deletions of items - should also be submitted via fax or email to reduce the possibility of errors.

Additions/Deletion of items will only be accepted within 48 hours after the initial order date and/or before 12:00PM on the date of the shipment. Additions of items placed after the 48 hours time period will be considered a new order and adhere to a new order freight prepaid policy. Deletions of item cannot happen after the 48 hours time period and/or after 12:00PM on the date of the shipment. Please note additions and/or deletions of items will delay the shipment date.

Canceling Orders:

Cancellation of orders must be submitted via fax or email within 24 hours of the order date. If the order has already shipped it will be the customers responsibility to return the order at the customers own expense. A restocking fee may apply, please see "Return" policy for further detail.

Backorders:

Customers have the option of having their backorders shipped or cancelled. Backorders resulting from a freight prepaid qualifying order will be shipped freight prepaid. UPI reserves the right to cancel backorders that are 6 months or older from the initial invoice date.

Minimum Order:

A minimum order of \$50.00 is required. Orders below \$50.00 will be assessed a minimum order fee of \$10.00.

Packaging:

A 10% service charge will be added to orders with special packaging or UPC barcoding requirements.

Lead Times:

Standard lead time for all United Pacific orders is 1-3 business days from the receipt of the purchase order. Larger orders may require a lead time of up to 5 business days. Transit time of 3-5 business days must be considered when placing orders. UPI cannot be responsible for delays in shipment after an order leaves our warehouse. UPI will work to resolve delays with freight forwarding firms, however, delays do arise from time to time due to weather and unforeseen circumstances beyond UPI's control. Express order are exempted; please view Freight/Shipping Policy for further detail.

Order Confirmation:

United Pacific will acknowledge receipt of orders by email/fax/telephone within 1 business day of receipt. If confirmation is not received, please contact UPI to ensure your order was received.

FREIGHT

Prepaid Freight:

Stock orders between \$50 and \$999.99 (US Lower 48 States), **\$50 and \$2499.99 (Alaska and Hawaii)**, **\$50 and \$1499.99 (Canada)**, [all price net US\$], will be shipped FOB Long Beach, California. Stock orders of \$1,000 (US Lower 48 States), **\$2500 (Alaska and Hawaii)**, **\$1500 (Canada)**, [based on UPI current pricing], or more will be shipped Freight Prepaid Ground to a single location only. (See exception for Oversize Items*). *Express Air orders, Special Net Pricing orders, and Special Quote Pricing orders are excluded.* United Pacific reserves the right to select the carrier of our choice. Customers may select the carrier of their choice at their own expense, negotiated rates and insurance. If customers elect to choose their own freight carrier, orders will be shipped via FREIGHT COLLECT.

***Oversize Item Freight Policy** - Applies to PB 379 Front Fenders, 60" or longer exhaust, and 18" or longer Saddle Boxes. 2 Options:

1. Freight will be prepaid by United Pacific if the total order of all items exceeds \$4,000 (US Lower 48 States) or **\$5000 (Hawaii, Alaska and Canada)**, [all price net US\$]. There will not be additional charges for these items included on the order.
2. Freight will be prepaid by United Pacific if a customer orders a total of \$2,500 (US Lower 48 States) or **\$3500 (Hawaii, Alaska and Canada)**, [all price net US\$], of PB 379 fenders, 60" or longer exhaust, and/or 18"+ Longer Saddle Boxes only. If the order is below \$2,500 (US Lower 48 States) or **\$3500 (Hawaii, Alaska and Canada)**, United Pacific will add freight charges to the order for the oversize items.

Will Call Orders:

Will Call orders can be picked up 2 - 4 hours after placing the order. Customers should always call ahead to confirm when order will be ready to pick up.

SHIPPING POLICY / CLAIMS

IMPORTANT: PLEASE REVIEW CAREFULLY

SHIPPING POLICY

International Shipments:

Shipments to locations outside the continental United States will be shipped to the customer's shipping agent or broker within the continental United States in accordance with the US freight policy. International customers will be responsible for the duties and taxes of their respective country.

Express Orders:

All express orders, such as Next Day, Second Day, 3 Day Service & Will Call, must be faxed/emailed. Order confirmation will be faxed to the customer for final approval. If confirmation is not received, please contact UPI to ensure your order was received. Customers are required to sign off on express orders and fax confirmation back to UPI. Cut off for express order is 12:00PM. Express orders received after 12:00PM may or may not ship the same day. Please call UPI to confirm projected shipping date or will call time.

Due to the high cost of express shipments, customer may request UPI to call to confirm freight charges. If customer does not request confirmation, UPI will ship the express order.

Drop Shipments:

All drop shipment orders will be assessed a \$10.00 processing fee. Drop shipment processing fee will be automatically added to the invoice without notice. All drop shipment orders must be faxed in. No freight allowance or prepaid freight will be permitted for any drop shipments, thus, all drop ship orders, regardless of order size, are FOB Long Beach, CA.

CLAIMS

General Policy:

All claims (Shortage, Mis-Shipped, Damage, Overage, Customer Error & Billing Error) must be submitted to UPI within 3 business days of the receipt of shipment. Claims submitted beyond 3 business days of the receipt of shipment will be voided by UPI.

On all shipments, the person who signs and receives the shipment is responsible for noting on the Bill of Lading, in writing, whether any boxes arrived damaged or shorted. Failure to do so will void all claim rights between all parties. UPI will have no recourse against the trucking company if customer does not note any damages or shortages on the Bill of Lading.

The customers receiving department must count and sign for the exact number of boxes received. Failure to follow the above instructions will void all claim rights between all parties.

Shortages / Mis-Ships / Damages

While UPI strives to fill every order with 100% accuracy, on occasion an item may get shipped in error or get damaged during shipping. In the event this occurs, please follow the process below. Note: This type of claim must be reported to UPI within three (3) business days of receiving the order.

- Contact the United Pacific office to initiate the claim. To make it easy for you we have two acceptable methods for requesting the claim:
 - * By e-mail : returns@uapac.com
 - * By fax : **(888) 986-5988**
 - * **Note: To ensure you receive a timely credit, we cannot accept claim requests by phone.**
- You will be required to provide the following information:
 - * Your business name
 - * Contact name and telephone number (in case we have questions)
 - * Date the order was received

- * A copy of the Packing List / Invoice noting the item number and quantity that was shipped in error or damaged during shipping.
- * Special instructions you have for us.

- UPI will send a return label so you can ship the items back.
- Once we receive the miss-shipped/damaged item(s) a credit will be issued to your account on the next billing cycle.
- Shortages will be credit to the Customers' account, unless customer would like the shortages replaced.

Overages:

UPI strives to provide our customers with the best customer service and products, in turn we would greatly appreciate any help from customer in notifying UPI of any shipping overages. Customers will be offered the option of retaining the merchandise or returning the merchandise to UPI at UPI's expense. If the items are to be returned, an RMA number and return shipping label will be provided.

Customer Errors:

Any item or quantity ordered in error by the customer may be returned by contacting UPI for a RMA No.

- To make it easy for you we have two acceptable methods for requesting the RMA:
 - * By e-mail: returns@uapac.com
 - * By fax: **(888) 986-5988**
 - * **Note: To ensure you receive a timely RMA credit, we cannot accept RMA requests by phone.**
- You will be required to provide the following information.
 - * Your business name
 - * Contact name and telephone number (in case we have questions)
 - * A list of the items number and quantity ordered in error
 - * Special instructions you have for us
- UPI will review the request to ensure the products are within the return period.
- Once we have validated the request, United Pacific will issue an RMA number to the customer. In issuing the RMA approval, the following conditions will apply :
 - * Returned items are subject to a 20% re-stocking fee.
 - * Return shipping costs are the responsibility of the customer.
 - * Items must not have any retail/price sticker on exterior packaging or they will be returned to the customer at customer's expense and no credit given.
 - * Items must be in good condition with original packaging intact or they will be returned to the customer at customer's expense and no credit given.
 - * Allow up to 30 days for the credit to be issued from the time the returned items are received.

Billing Errors:

Billing errors should be reported to UPI within 3 business days of invoice receipt. Customers are asked to provide the invoice number, part number, and quantities in question. Once verified, UPI will issue a credit or an invoice for the difference in billing error.

WARRANTY POLICY / RETURNS

IMPORTANT: PLEASE REVIEW CAREFULLY

WARRANTY POLICY

General Policy:

UPI offers a NO HASSLE WARRANTY RETURN policy to all our customers. Warranty claims can only be submitted through an authorized UPI Distributor. UPI warranty is not transferable and applies to the original installation and purchase only. In no event shall UPI be liable for incidental or consequential damages, nor shall UPI be liable for any claims or damages arising out of or connected with the UPI warranty exceed the purchase price of the products. There are no warranties, expressed or implied (including any warranty of merchantability or fitness) that extend beyond this warranty. The warranty does not apply to costs associated with the loss of use of the product, loss of time, inconvenience, commercial loss, incidental or consequential damages. UPI reserves the right to alter the designs of products without assuming any obligation to modify previously manufactured products and will only replace warrantied products with redesigned products.

Warranty does not apply to merchandise that has been drilled, cut, welded, modified in any way or installed contrary to normal installation and usage. In addition, UPI cannot be held liable for damages caused by road hazards, accidents, misuse, neglect, abuse or corrosive environments including acid washes and highway snow/ice chemicals which can cause discoloration and corrosion in aluminum, chrome, stainless steel and light products. UPI reserves the right to credit returned merchandise at the initial purchase price or at the current selling price, which price ever is lower.

Aluminum / Chrome / Stainless Steel Products:

All aluminum, chrome, and stainless steel products carry a limited 6 month warranty (from invoice date) against defects in material or workmanship.

Lighting Products:

Incandescent

All incandescent lighting products carry a limited 12 month warranty (from invoice date) against defects in material or workmanship. The limited 12 month warranty does not apply to several applications, such as, buses, construction equipment, and off road vehicles.

LED

All LED lighting products carry the following limited warranty (from invoice date) against defects in material or workmanship.

- * LED Marker, 2", 2 1/2", 4", Oval & Square Lights - Limited Lifetime Warranty (Light W/ Chrome/Stainless Bezel or Housing only carry a 6 Month Limited Warranty)
- * LED Cab, Double/Single Stud Turn Signal, PB/KW/FL Turn Signal & Strip Lights - 10 Year LED Limited Warranty (Light W/ Chrome/Stainless Bezel or Housing only carry a 6 Month Limited Warranty)
- * LED Beacon, Driving, Headlights, Work, & Warning Lights - 3 Year Limited Warranty (Light W/ Chrome/Stainless Bezel or Housing only carry a 6 Month Limited Warranty)
- * All LED Accessory Lights (Honda, Stainless Steel Double/Single Face Lights, Interior LED, License, & Lights W/ Chrome/Stainless Steel Bezel or Housing) - 6 Month Limited Warranty

RETURNS

General Policy:

All returns must be authorized by UPI. All return requests must be faxed or e-mailed (returns@uapac.com) A RMA number (Return Merchandise Authorization Number) will be provided. Returns not possessing a valid RMA number are subject to rejection and will be returned to sender at the customer's expense.

All customers are encouraged to use the Warranty RMA Claim Form.

Defective Goods / Warranty Return:

UPI offers our customers a No Hassle Warranty Return. Please follow the instructions below for requesting a RMA for defective goods:

1. If any warranty issues occur, simply contact the UPI for RMA number To make it easy for you we have two acceptable methods for requesting the RMA:
 - * By e-mail: returns@uapac.com
 - * By fax: **(888) 986-5988**

*** Note: To ensure you receive a timely RMA credit, we cannot accept RMA requests by phone.**
2. You will be required to provide the following information:
 - * Your business name
 - * Contact name and telephone number (in case we have questions)
 - * A list of the defective item number and quantity with the nature/reason of the defect
 - * Special instructions you have for us
 - * The enclosed fax form may be used for your convenience to request an RMA
3. UPI will review the request to ensure the products are within the stated warranty period.
4. Once we have validated the warranty items, a RMA confirmation, listing the items and cost will be faxed to the customer within 3 business days. UPI will process the credit to your account within 30 days.

Note: There will be no need to return the warranty product to us. However, from time to time, UPI may require some warranty products to be shipped back so we may analyze the cause of the failure. All warranty products that are required to be shipped back will be freight prepaid by UPI.

Stock Return

United Pacific Industries encourages all customers to regularly monitor the sales volume and stock level of their inventory items. As sales trends may slow the movement of specific items, our hope is that those items are featured as "close-out specials" as to minimize stock returns. We also understand that the customer, from time to time, may accumulate over-stock items and desire to return those. Therefore, we have adopted the following policy below.

NOTE:

- * Items must have been purchased by the dealer requesting the stock return.
- * Items must have been purchased within the preceding 12 months.
- * Items that have been discontinued will not be considered for return.

1. Contact the United Pacific office for RMA number We have 2 acceptable methods for requesting the RMA:

By e-mail : returns@uapac.com

By fax : **(888) 986-5988**

Note: To ensure you receive a timely RMA credit, we cannot accept RMA requests by phone.

2. You will be required to provide the following information:
 - * Your business name
 - * Contact name and telephone number (in case we have questions)
 - * A list of defective items: Item numbers and quantity of each
 - * Special instructions you have for us
3. Your claim will be reviewed within 5 business days and you will be contacted by your sales representative who will discuss solutions to liquidate these slow moving items.
4. In the event United Pacific and the customer agree to a credit in lieu of

RETURNS / CATALOGS / DISCLAIMER

IMPORTANT: PLEASE REVIEW CAREFULLY

returning the items, this credit will be issued within 10 business days.

- In the event items are returned by the customer, United Pacific will issue an RMA number to the customer. In issuing the RMA approval, the following conditions will apply:
 - * Returned items are subject to a 20% re-stocking fee.
 - * Return shipping costs are the responsibility of the customer.
 - * Items must not have any retail/price sticker on exterior packaging or they will be returned to the customer at customer's expense and no credit given.
 - * Items must be in good condition with original packaging intact or they will be returned to the customer at customer's expense and no credit given.
 - * Allow up to 30 days for the credit to be issued from the time the returned items are received
- Stock returns may be requested throughout the year and are subject to a maximum of 5% of prior year annual purchases.

Closeout/Discontinue Items:

UPI will not warranty or accept returns on Closeout/Discontinue items.

Procedure:

An inventory of the merchandise being returned must accompany each return. The RMA number should be prominently displayed on each carton/box.

All Returns must be returned freight prepaid.

Ship Returns to:

United Pacific Industries
Attn: Returns Department
3788 E. Conant St.
Long Beach, CA 90808

RMA's:

Outstanding RMA's will be automatically cancelled if not used within 30 days of issuance.

CATALOGS

General Policy:

UPI will send a set of catalogs and price lists upon the arrival any new catalogs and price list. Included in the mailing will be a Catalog Order Form in which customers can request additional copies.

Catalog/CD Request:

UPI provides additional catalogs/CD's to our customers free of charge. Customer must submit their request on a UPI Catalog Order Form or add the request to their regular restocking order. Requests for additional catalogs/CD's should be submitted along with the regular restocking orders to avoid additional freight charges. Due to the availability of catalogs/CD's, customer's request may be limited to certain quantity. Catalogs/CD's will be shipped along with the customers' order. Customer may request the catalogs be shipped separately, but customer will be responsible for the freight charge.

Picture Request

All UPI item pictures are taken professionally by our marketing department. Item pictures can be downloaded online at www.uapac.com. Item pictures not posted online can be requested by sending an email to e-mail graphic@uapac.com. All picture requests must state the item no and the format of the picture file, i.e jpeg or high resolution. UPI has over 20,000 SKU's and therefore does not have a CD with all the items.

DISCLAIMER

United Pacific Industries reserves the right to amend or update our Policies & Procedures without notice.

RMA FORM SAMPLE



DEFECTIVE GOODS / WARRANTY CLAIM FORM

UNITED PACIFIC INDUSTRIES, INC.
 3788 CONANT STREET
 LONG BEACH, CA 90808
 DIRECT: (562) 438-5988
 TOLL FREE: (800) 763-6100
 TOLL FREE FAX: (888) 986-5988

Date: _____
 Company Name: _____
 Address: _____
 City, State, Zip: _____
 Contact Name: _____
 Phone Number: _____
 Fax Number: _____
 Email: _____

List defective items below:

Item#	Qty	Description	Reason for Defect	Date Sold to Customer

Any special notes / instructions for United Pacific (list here):

File your claim at:
 by email - returns@uapac.com
 by fax - (888) 986-5988

Internal Use Only	
Date Received: _____	Final RMA: _____
RMA Approval Date: _____	Credit Amount: _____
RMA Number: _____	Approved by: _____

CATALOG ORDER FORM SAMPLE



UNITED PACIFIC CATALOG ORDER FORM

UNITED PACIFIC INDUSTRIES, INC.
 3788 CONANT STREET
 LONG BEACH, CA 90808
 TEL: (562) 438-5988
 FAX: (562) 598-5988
 TOLL FREE: (800) 763-6100

Date: _____
 Company Name: _____
 Address 1: _____
 Address 2: _____
 City, State, Zip: _____
 Contact Name: _____

Item #	Description	Quantity	Total
1	CDKW1 UP INTERIOR PRODUCT CATALOG - KENWORTH, CD ROM EDITION		
2	CDPB1 UP INTERIOR PRODUCT CATALOG - PETERBILT, CD ROM EDITION		
3	UCAC1 UP AIR CLEANER CATALOG, 1 ST EDITION		
5	UCEH1 UP EXHAUST CATALOG 1 ST EDITION		
6	UCFL2 UP INTERIOR PRODUCT CATALOG - FREIGHTLINER, 2 ND EDITION		
7	UCFM2 UP FENDER, REAR LT BAR/PANEL, MUD FLAP ACCESSORIES, 2 ND EDITION		
8	UCHI1 UP INTERNATIONAL PRODUCT CATALOG, 1 ST EDITION		
9	UCKS2 UP KEYSTONE POLISHING CATALOG, 2 ND EDITION		
10	UCKW2 UP INTERIOR PRODUCT CATALOG - KENWORTH, 2 ND EDITION		
11	UCLT2 UP MASTER LIGHTING CATALOG, 2 ND EDITION		
12	UCMFL1 UP MINI FREIGHTLINER INTERIOR PRODUCT CATALOG		
13	UCMKW1 UP MINI KENWORTH INTERIOR PRODUCT CATALOG		
14	UCMKWS1 UP MINI SPANISH KENWORTH INTERIOR PRODUCT CATALOG		
15	UCMPB1 UP MINI 2005+ PETERBILT INTERIOR PRODUCT CATALOG		
16	UCNW2 UP NUT COVER & WHEEL PRODUCT CATALOG, 2 ND EDITION		
17	UCPB2 UP INTERIOR PRODUCT CATALOG - PETERBILT, 2 ND EDITION		
18	UCSC2 UP SPECIALTY COLLISION CATALOG 2 ND EDITION		
19	UCHT2 UP TRAIN HORN & AIR COMPRESSOR CATALOG, 2 ND EDITION		
20	UF1210 2011 UP ANNUAL NEW ITEM SUPPLEMENT (NEW ITEM FROM 2010)		
21	99046 UNITED PACIFIC DELUXE BINDER 3 1/2" THICK		
22	UCB COMPLETE COLLECTION OF UP CATALOGS with BINDER 96046		

Any special notes / instructions for United Pacific (list here):

Please read the following policies for ordering catalogs:

A) All orders for brochures, catalogs, and price books will be shipped with the customers' next regular order.

B) If you want your brochures to ship independent of your next order, extra shipping fees will be applied and billed to your account. Please approve the shipping fees by providing a signature below.

Signature X _____

UPI-C01

HOT ITEMS



Aluminum Housing



LED Position Light



High Power LED



6" x 4" Rectangular High Power LED Crystal Headlight

Description

- 6" x 4" Rectangular Crystal Headlight with 1 High Power LED and 6 LED Position Lights
- Available in Low Beam or High Beam Modules Only
- Solid State Design Resists Shock and Vibration, Impact Resistant Polycarbonate Lens Provides Unparalleled Protection from Road Hazards
- Improve Visibility with Whiter Light Output that is Closer to Daylight
- Die-Cast Aluminum Housing Provides Maximum Protection from the Elements
- Load Resistor May be Required for Proper Installation
- SAE/DOT FMVSS108, **3 Year Warranty**

Item Number	Description	Package	Pack
31356	Low Beam	Boxed	1 Pc./Box
31357	High Beam	Boxed	1 Pc./Box

Technical Specifications

Low Beam Version

12-24V DC Input
0.50-0.60 Amps @ 13.5V DC (9W)
0.25-0.35 Amps @ 28V DC (10W)
FMVSS108

High Beam Version

12-24V DC Input
0.90-1.10 Amps @ 13.5V DC (15W)
0.50-0.60 Amps @ 28V DC (17W)
FMVSS108

HOT ITEMS



6" x 4" Rectangular High Power LED Headlight

Description

- 6" x 4" Rectangular Headlight with 1 High Power Cree LED
- Available in Low Beam or High Beam Modules Only
- Solid State Design Resists Shock and Vibration, Impact Resistant Polycarbonate Lens Provides Unparalleled Protection from Road Hazards
- Improve Visibility with Whiter Light Output that is Closer to Daylight
- Die-Cast Aluminum Housing Provides Maximum Protection from the Elements
- Load Resistor May be Required for Proper Installation
- SAE/DOT FMVSS108, **3 Year Warranty**

Item Number	Application	Package	Pack
31396	Low Beam	Carded	1 Pc./Card
31397	High Beam	Carded	1 Pc./Card

Technical Specifications

Low Beam Version

12-24V DC Input
 0.80 Amps @ 12.8V DC (10.1W)
 0.35 Amps @ 28.0V DC (8.96W)
 FMVSS108

High Beam Version

12-24V DC Input
 1.10 Amps @ 12.8V DC (15.7W)
 0.50 Amps @ 28.0V DC (14.56W)
 FMVSS108

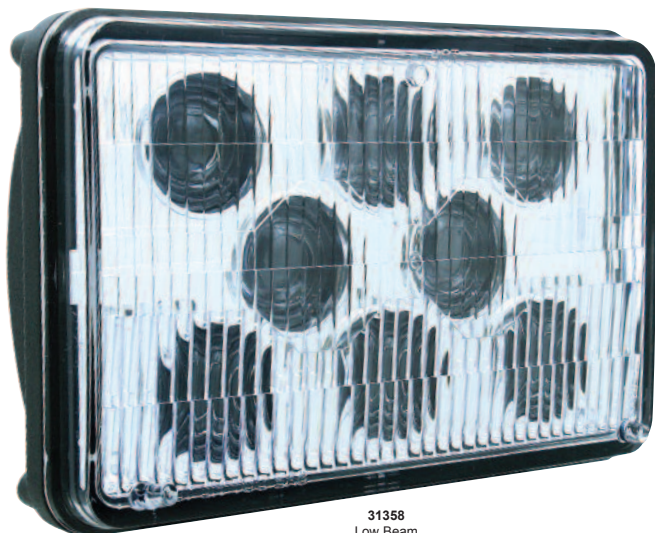

31358
Low Beam



31359
High Beam

8 High Power LED 6" X 4" Rectangular Headlight

Description

- 6" x 4" Rectangular Headlight with 8 High Power LED
- Available in Low Beam or High Beam Modules Only
- Solid State Design Resists Shock and Vibration, Impact Resistant Polycarbonate Lens Provides Unparalleled Protection from Road Hazards
- Improve Visibility with Whiter Light Output that is Closer to Daylight
- Die-Cast Aluminum Housing Provides Maximum Protection from the Elements
- Load Resistor May be Required for Proper Installation
- SAE/DOT FMVSS108, **3 Year Warranty**

Item Number	Description	Package	Pack
31358	Low Beam	Boxed	1 Pc./Box
31359	High Beam	Boxed	1 Pc./Box

Technical Specifications

Low Beam Version

12-24V DC Input
 1.85 Amps @ 12.8V DC (23.7W)
 0.85 Amps @ 28.0V DC (23.7W)
 FMVSS108

High Beam Version

12-24V DC Input
 1.85 Amps @ 12.8V DC (23.7W)
 0.85 Amps @ 28.0V DC (23.7W)
 FMVSS108

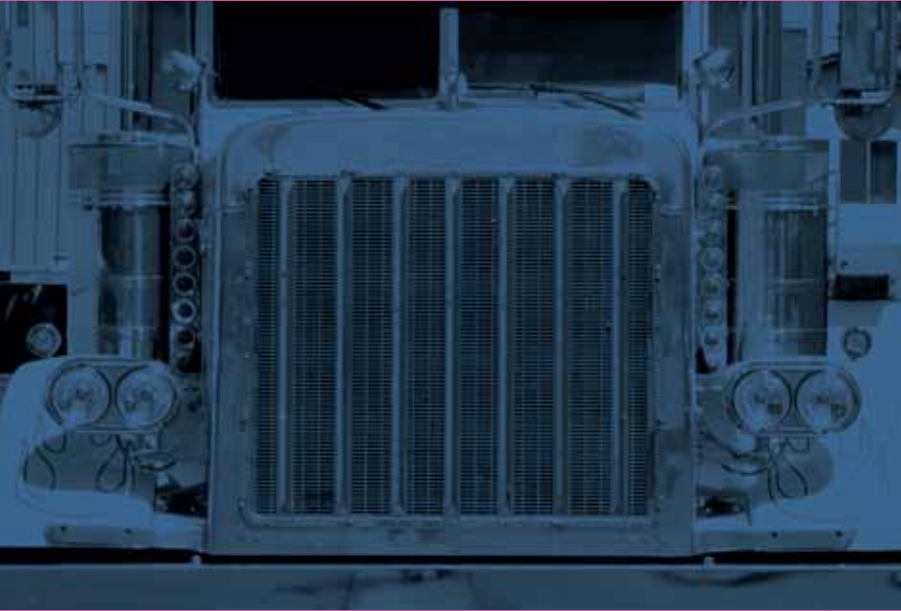

www.uapac.com

3788 E. Conant St., Long Beach, CA 90808

Fax: (888) 986-5988

Toll Free: (800) 790-6988

sales@uapac.com



Know It First. Follow Us on FACEBOOK
Type "UNITED PACIFIC INDUSTRIES"

UCWL1

WORK, DRIVING, AND WARNING
LIGHT CATALOG- 1ST EDITION



710270095247